



topone

SP SERIES

Double Column Machining Center

**Provide the accuracy and productive capacity
you need for profitable machining.**

- Rugged and precision construction throughout
- Heavy cutting capability
- Lifetime accuracy
- Improved surface finish



PERFECTLY DESIGNED TO OPTIMIZE MACHINING EFFICIENCY

Now, you can get the right double column machining center with the right features for extra heavy cutting operations. Each machine is quality constructed throughout with user-appreciated features.



APPLICATIONS

Top-One Double Column Machining Centers exhibit outstanding rigidity, precision, quality and performance. Each one is designed for machining large, complex parts and precision molds, and creates the accuracy and efficiency you've come to expect. To meet customers' specific machining requirements, custom specifications are available.



[Energy sector]



[Wind turbine]



[Electricity generation equipment]

is manufactured with the tradition of Top-One's quality excellence.



[Heat exchanger]



[Automotive industry]



[Ship building industry]

HEAVY DUTY! RUGGED! STABLE!

What you can expect from Top-One's machine structure!

- Exceptionally high dynamic accuracy
- Minimized thermal displacement
- Can handle heavy cutting
- Deformation free
- Improved surface finish

SCIENTIFIC RIB REINFORCEMENT

All structural parts of Top-One's double column machining centers are internally reinforced with comprehensive heavy ribs to resist flex and minimize vibrations.



Optimal reinforce ribbed bracket design for cross beam is capable for heavy load, high stiffness, anti-bending, and high accuracy.



The transverse & vertical reinforced ribbed for columns is constructed by inner and core boxes comes with thick wall design to have high rigidity, high stiffness, anti-bending and steady support on the cross beam



LARGE INTERNAL SPACE

The extra wide distance between columns in combination with extra long travel allows the machine to accommodate large workpieces.



MASSIVE, STABLE BASE

- The base is manufactured from high quality Meehanite cast iron, tempered and stress relieved to ensure material stability without deformation year after year.
- Scientific rib reinforcement in combination with a greater span between linear ways provides solid support for heavy loads.



DOUBLE V SLIDE WAY FOR X-AXIS (Optional)

The double V is an optional choice which designed to use Hydrostatic pressure system to hold the extremely heavy work-piece on the work table.



LARGE DIAMETER BALL SCREWS

- The 3 axes traverses are driven by high performance servo motors, which drive the ball screws, feature minimum backlash and long life.
- Ball screws are pre-tensioned to assure high-transmission accuracy at all times.





LADDER TYPE LINEAR WAYS ON BEAM

- The linear ways on the beam are supported by a ladder structure that upgrades stability of the spindle head.
- The heavy duty roller type linear ways combined with three slide blocks on each linear way guarantee greater rigidity on the y-axis.



TWO CHIP AUGERS ON BASE

Two chip augers are provided at the left and right side of the base, which deliver chips to the chip conveyor. The chip augers maintain machine cleanliness at all times.

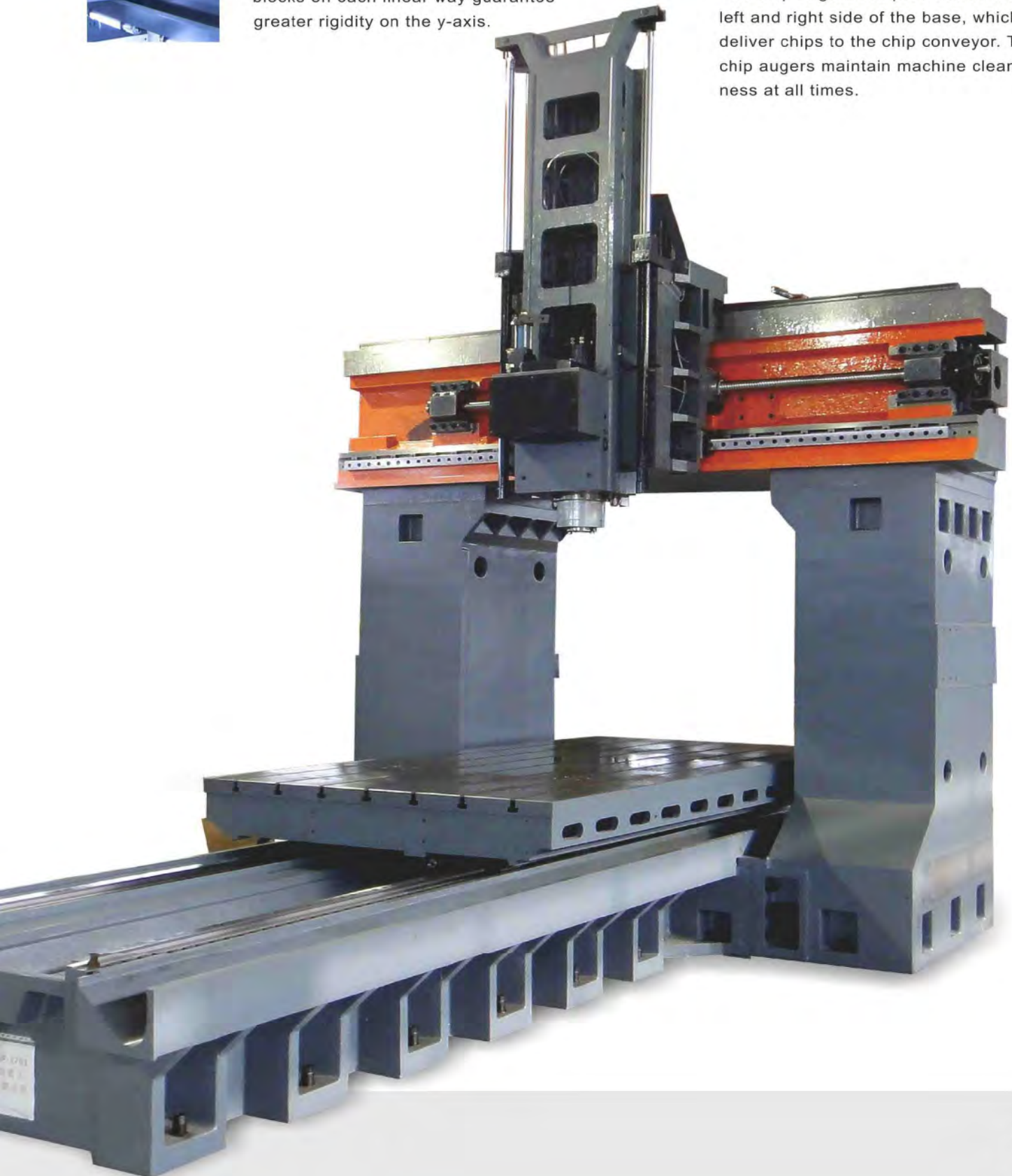

SPINDLE

Gear Drive Spindle

4500 rpm (BT50)

6000 rpm (BT50) (option)

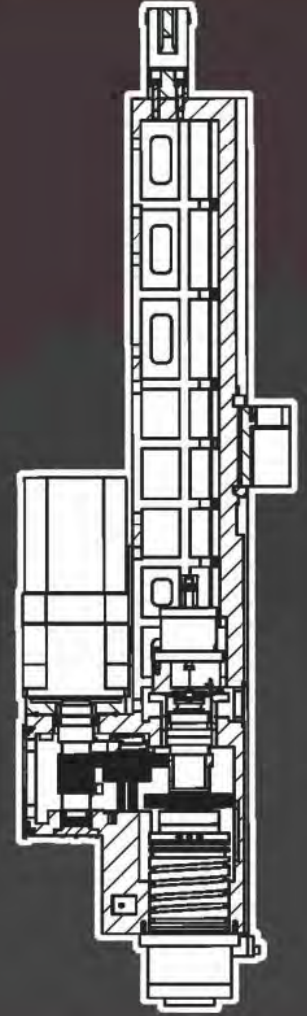

All Gear Spindle Head

TWO-STEP SPEED GEARBOX

- The spindle running is transmitted through a gearbox, providing high/low speed changes.
- The low speed range gives great torque output, making the machine excellent for heavy cutting. The high speed range is ideal for fine cutting with outstanding surface finish effects.
- All gears in the gearbox are carburized and precision ground for quiet running.

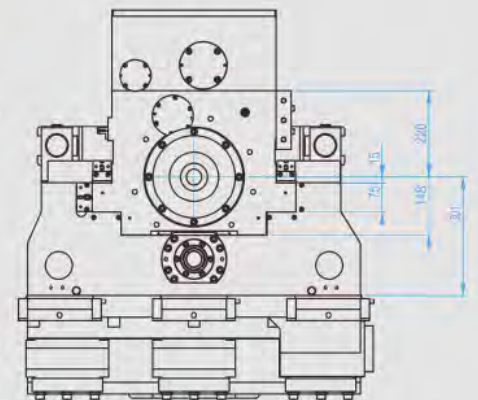

Spindle Speed 50~6000rpm

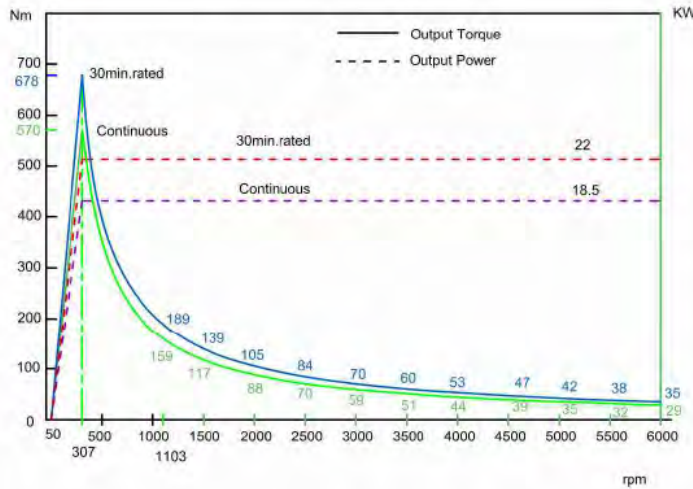

Spindle Speed 50~4500rpm

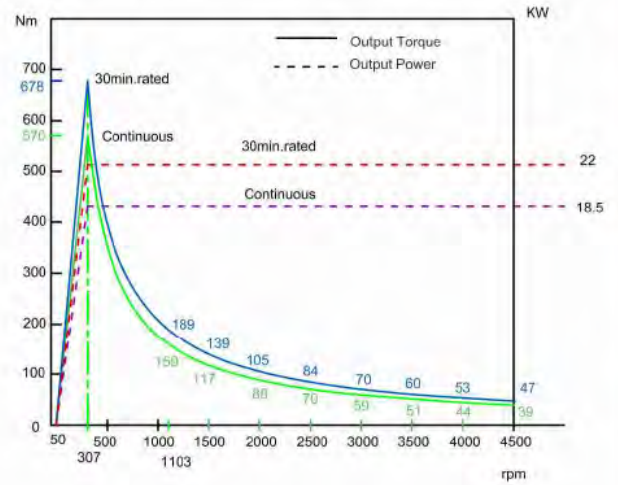

Fanuc-Spindle Motor α 18
Spindle Speed & Torque Curve

OPTIMAL SPINDLE HEAD LAYOUT

- The spindle center line closes to z-axis slideways, greatly reducing the possibility of thermal displacement and bending deformation due to side cutting torque.
- Driven by a powerful motor, the spindle head is ideal for various complicated machining with ultra-high accuracy.
- Spindle gearbox is designed as rectangular in cross-section and its structure is symmetrical closed. It ensures the spindle gear box symmetrical heat conduction and preventing thermal distortion and minimizing deflection.



HYDRAULIC & NITROGEN GAS DUAL COUNTER-BALANCING SYSTEM

- The nitrogen gas counter-balancing system is equipped with an accumulator, and no additional power unit is required.
- Features no noise and no vibration.
- It ensures extra smooth movement of the spindle head for increased machining accuracy.

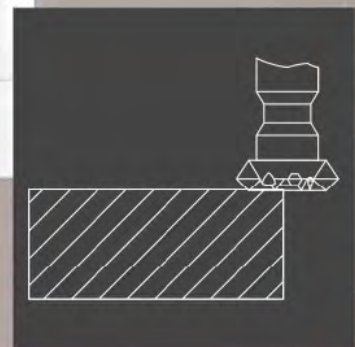

FACE MILLING

Cutting tool: $\text{Ø}125 \times 8t$

Tangential speed: **295.35 m/min**

Cutting width: **120 mm**

Cutting depth: **4 mm**

Cutting feed rate: **140 mm/min**

Cutting amount per tooth: **0.27 mm**

Material removal rate: **756 mm**

Workpiece material: **S45C**

Spindle load: **80 %**

Cutting capacity
YOU'VE COME TO EXPECT!

EXTRAORDINARY CUTTING CAPABILITY

TOP-ONE double column machining centers will dramatically increase your productivity. Let our cutting tests prove it!

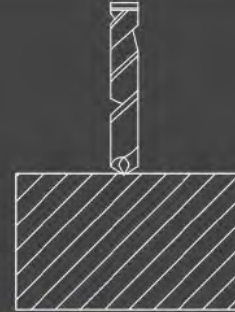

DRILLING

Tool diameter: **Ø90 mm**

Tool material: **Tungsten Carbide**

Cutting depth: **100 mm**

Cutting feed rate: **5 mm/min**

Workpiece material: **SUS304**

Spindle load: **48%**

Cutting Test Report

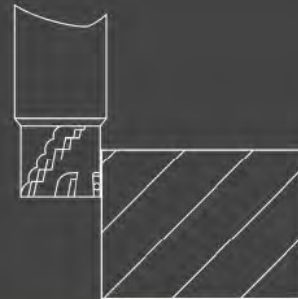

END MILLING

Cutting tool: **Ø32 x 8t**

Tangential speed: **158.6 m/min**

Cutting width: **6 mm**

Cutting depth: **20 mm**

Cutting feed rate: **120 mm/min**

Cutting amount per tooth: **0.21 mm**

Material removal rate: **187 c.c/min**

Workpiece material: **Ø125 x 8t**

Spindle load: **65%**



Note: The above cutting test values are for reference only. The values may vary with customers cutting conditions.

SPECIALTY OF THE HEAVING-DUTY CUTTING & OVERLOAD



Top-One is specialty in design and manufacture the heavy-duty and overload double column machining center.

All main castings are designed for high rigidity capability and made by high grade cast irons, no welding metal been used. Heavy table load models are using the double V slide way on X axis travel and adhesive Anti-deforming Turcite B on the slide way provide extended machine life and movement.



Use zero backlash gear driven on X-axis over 7 meters travel.

The driven is more powerful, high efficiency and better accuracy in movement.



All of the contact surfaces with the box way are hand scrapping by our extraordinary scrapping craftsmanship to achieve the accuracy of the each machine. Microalignment by hand scrapping can make the machine stronger foundation and higher level of accuracy.



Table V slide way distribute the oil to X axis box way to ensure the X-axis has sufficient and steady oil lubricate. And Individual lubricated system can be filter the lube oil and recycle.

DYNAMIC BALANCE CALIBRATION

All spindle motors and spindles are subject to dynamic balance calibration before assembly. With the dynamic balance calibration, the spindle vibration is minimized during high speed running. This also results in high machining accuracy.

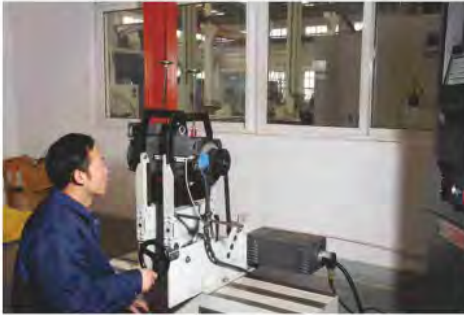

QUALITY ASSURANCE

TOP-ONE's reputation for quality excellence results from rigorous and thorough quality control.



BALL BAR TESTING

After assembly, each machine is tested by using the latest ball bar testing equipment. With ball bar testing, we can calibrate circularity and the machine's geometrical accuracy.

Circular cutting tests are also performed to ensure the 3D cutting accuracy and the circular smoothness.

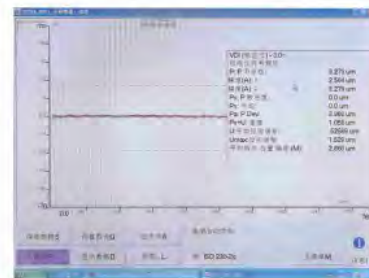

LASER INSPECTION ON THREE AXES

Each machine is inspected using an advanced laser unit for calibration. The laser unit is applied for inspecting and calibrating the screw pitch error, backlash, positioning accuracy and repeatability. The precision inspection may ensure the dynamic and static ability of the machine and its machining accuracy.

STANDARD ACCESSORIES

CNC CONTROLLER



FANUC 0i-MF



MITSUBISHI M70V



SIEMENS 828D



PENDENT ARM TYPE FOR CONSOLE

360 degree swivel for the Console, easy use for the operator, the pendent arm can left/right any angle movement, up/down movement.

Full guarding enclosure, over 5 meter in X-axis travel.



SPINDLE OIL COOLER

- The spindle oil cooler can be adjusted as desired to control the spindle temperature.
- It provides an outstanding cooling effect that reduces gear temperature, ensures consistent spindle accuracy and extends service life of spindle and gearbox.



HIGH PRESSURE AUTOMATIC LUBRICATOR

- The high pressure forced automatic lubricator employs an oil distributor. Once pressure reaches its peak, all lubrication points are released.
- The oil circuit features pressure detection and feed back. It can detect oil circuit jamming and leaks. This allows all lubrication points to be properly lubricated at all times, and ensures a longer service life and accuracy of the machine.

OPTIONAL ACCESSORIES



COOLANT THROUGH SPINDLE:
(20bar/50 bar/70bar)



CHAIN-TYPE MAGAZINE (OPTIONAL)
40, 60 TOOLS

- The tool magazine accepts BT50 tool shanks.
- The tool magazine is side mounted to prevent contamination from chips or coolant.
- Customize tool magazine capacity

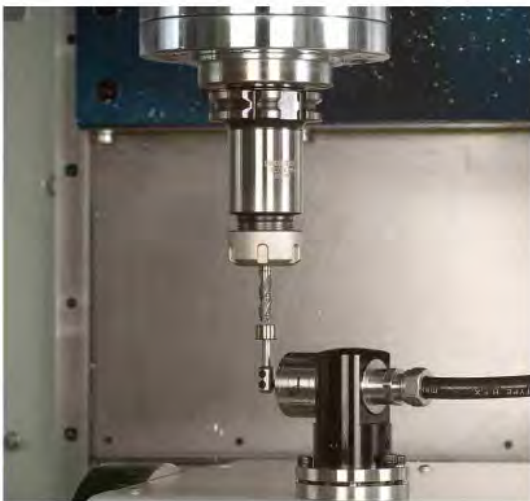

RENISHAW TS-27R
AUTOMATIC TOOL LENGTH
AND TOOL DIAMETER
MEASURING DEVICE

RENISHAW RMP-60
AUTOMATIC WORKPIECE
CENTER MEASURING DEVICE



4TH AXIS ROTARY TABLE



LINEAR SCALE



OIL WATER SEPARATING TANK

Multi-Angle Head Attachment

Unit:mm

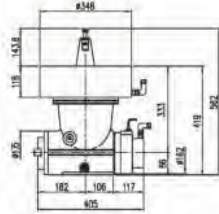

Head/Tool Clamping	Manual
Indexing	Automatic 5°
Max Cutter Dia	φ150
Max Torque	1200N.m
Max Power	38KW
Max Speed	2000rpm

N75B-90 Head

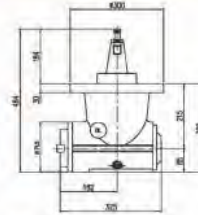

Head/Tool Clamping	Manual
Indexing	Manual
Max Cutter Dia	φ150
Max Torque	1200N.m
Max Power	38KW
Max Speed	2000rpm

N75C-90 Head

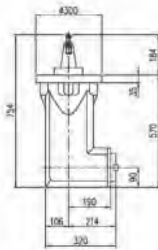

Lock/Lock knife	Manual
Indexing	Manual
Max Cutter Dia	φ200
Max Torque	1200N.m
Max Power	38KW
Max Speed	1200rpm

N74BTS-90 Deep Boring Head

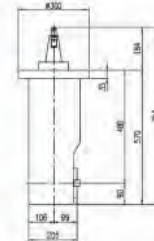

Head/Tool Clamping	Manual
Indexing	Manual
Max Cutter Dia	φ200
Max Torque	1200N.m
Max Power	38KW
Max Speed	800rpm

A74-90 Deep Boring Head

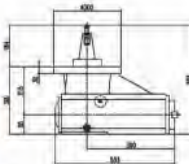

Head/Tool Clamping	Manual
Indexing	Manual
Max Cutter Dia	φ150
Max Torque	1200N.m
Max Power	38KW
Max Speed	2000rpm

B75-90- Head

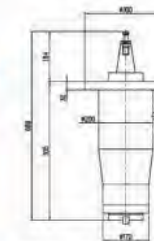

Head/Tool Clamping	Manual
Indexing	N/A
Max Cutter Dia	φ150
Max Torque	1200N.m
Max Power	38KW
Max Speed	2000rpm

E75N-Extend The Head

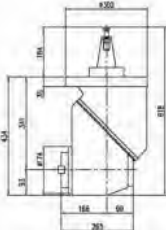

Head/Tool Clamping	Manual
Indexing	Manual
Max Cutter Dia	φ200
Max Torque	1200N.m
Max Power	42KW
Max Speed	1200rpm

C50-Universal Head

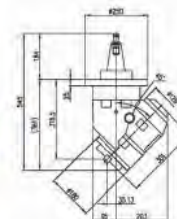

Lock/Lock knife	Manual
Indexing	Manual
Max Cutter Dia	φ150
Max Torque	1000N.m
Max Power	38KW
Max Speed	2000rpm
Spindle angle	45°/30°

N45/N30 Angle Head

TOOL SHANK SIZE

MAS 403-P50T-1

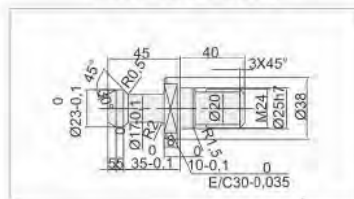

ISO 7388/2-B,PS-CAT50

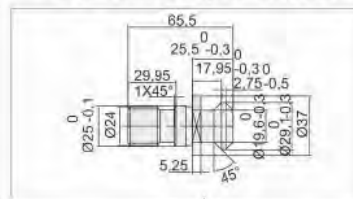

DIN 69872 TYPE A

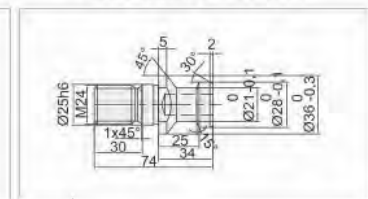

BT-50

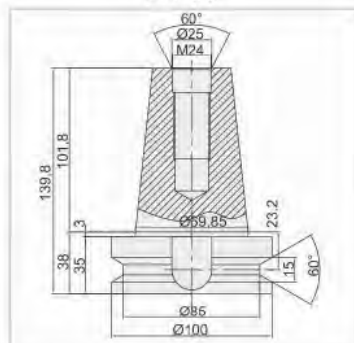

ISO 7388/1-50,CAT-50

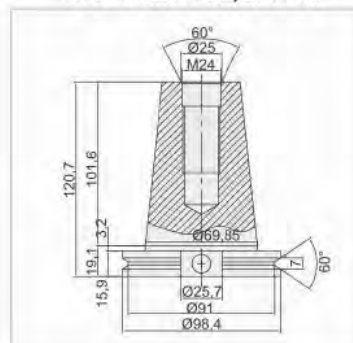

DIN 69871 Form A

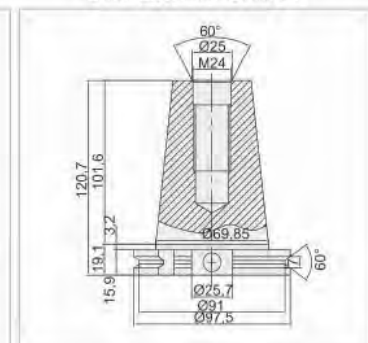

Unit:mm

Machine Dimension

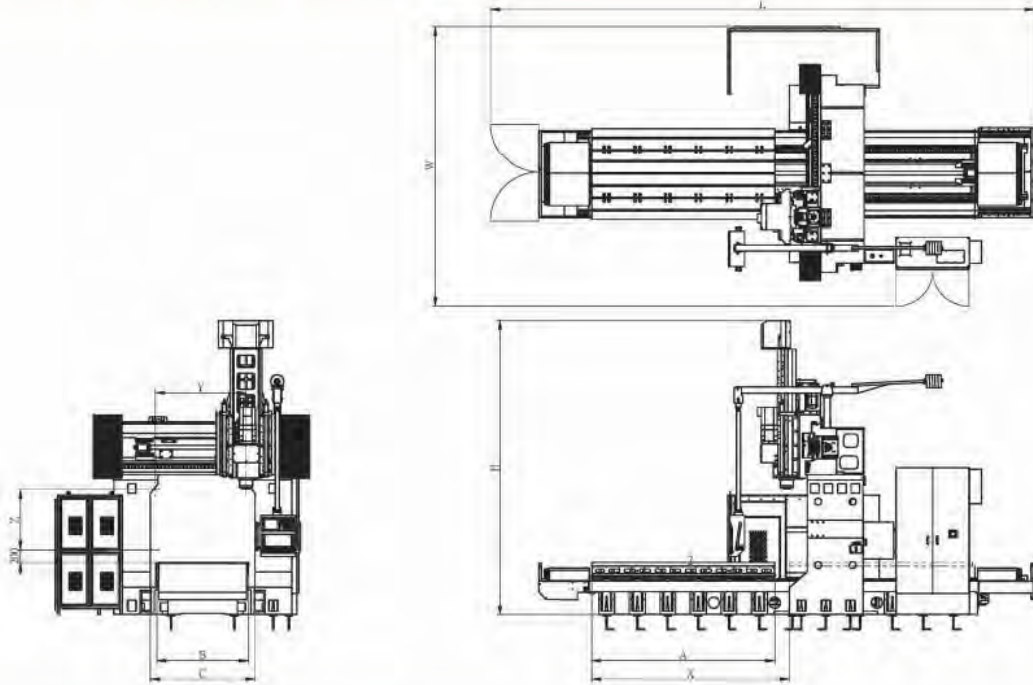

Machine Dimension																	Unit : mm
MODEL	SP-1703	SP-1704	SP-2203	SP-2204	SP-2205	SP-2206	SP-2703	SP-2704	SP-2705	SP-2706	SP-3204	SP-3205	SP-3206	SP-3704	SP-3705	SP-3706	
L	9000	11000	9000	11000	13000	15000	9000	11000	13000	15000	11000	13000	15000	11000	13000	15000	
W	4600	4600	5250	5250	5250	5250	5750	5750	5750	5750	6250	6250	6250	6750	6750	6750	
H (Z ST:1000)	4850	4850	4850	4850	4850	4850	4850	4850	4850	4850	4850	4850	4850	4850	4850	4850	
H (Z ST:1200)	5360	5360	5360	5360	5360	5360	5360	5360	5360	5360	5360	5360	5360	5360	5360	5360	
H (Z ST:1400)	6050	6050	6050	6050	6050	6050	6050	6050	6050	6050	6050	6050	6050	6050	6050	6050	
X	3000	4000	3000	4000	5000	6000	3000	4000	5000	6000	4000	5000	6000	4000	5000	6000	
Y	1600	1600	2100	2100	2100	2100	2600	2600	2600	2600	3100	3100	3100	3600	3600	3600	
Z	1000(1200/1400)																
A	3000	4000	3000	4000	5000	6000	3000	4000	5000	6000	4000	5000	6000	4000	5000	6000	
B	1500	1500	1800	1800	1800	1800	2200	2200	2200	2200	2700	2700	2700	3200	3200	3200	
C	1700	1700	2200	2200	2200	2200	2700	2700	2700	2700	3200	3200	3200	3700	3700	3700	

Table Dimension

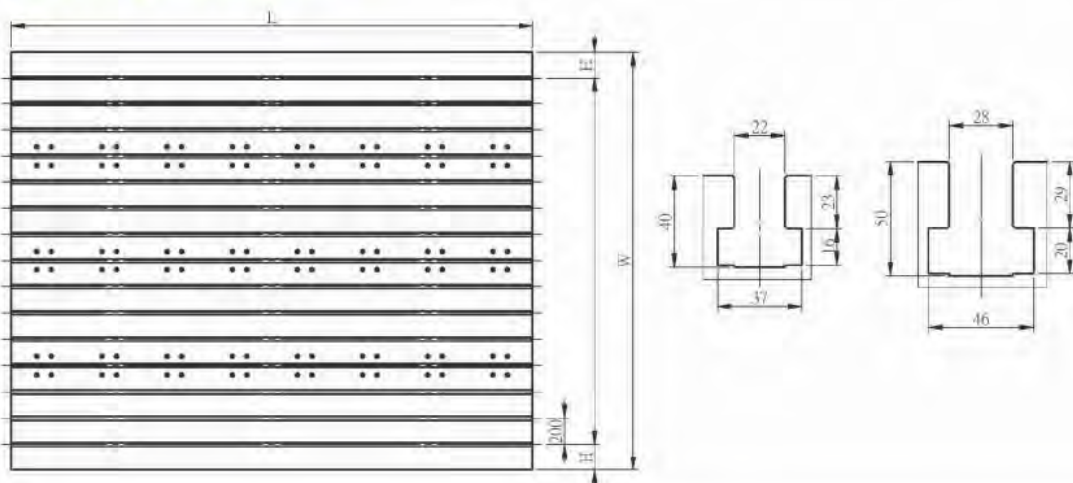

Table Dimension																	Unit : mm
MODEL	SP-1703	SP-1704	SP-2203	SP-2204	SP-2205	SP-2206	SP-2703	SP-2704	SP-2705	SP-2706	SP-3204	SP-3205	SP-3206	SP-3704	SP-3705	SP-3706	
L	3000	4000	3000	4000	5000	6000	3000	4000	5000	6000	4000	5000	6000	4000	5000	6000	
W	1500	1500	1800	1800	1800	1800	2200	2200	2200	2200	2700	2700	2700	3200	3200	3200	
pcs	7	7	9	9	9	9	11	11	11	11	13	13	13	15	15	15	
SIZE	22	22	22	22	22	22	22	22	22	22	28	28	28	28	28	28	
H	150	150	100	100	100	100	100	100	100	100	150	150	150	200	200	200	

SPECIFICATIONS

MODEL	UNIT	SP-1703	SP-1704	SP-2203	SP-2204	SP-2205	SP-2206
ITEM		(Double V Slide way Optional)					
X-axis travel	mm	3000	4000	3000	4000	5000	6000
Y-axis travel	mm	1600	1600	2100	2100	2100	2100
Z-axis travel	mm	1000 (1200 / 1400)					
Table area	mm	1500x3000	1500x4000	1800x3000	1800x4000	1800x5000	1800x6000
T-slot (no.-size x pitch)	mm	7-22x200	7-22x200	9-22x200	9-22x200	9-22x200	9-22x200
no. Of linear ways / slide blocks		2 / 6	2 / 8	2 / 6	2 / 8	2 / 10	2 / 12
Max. table load / Linear Ways	t	6	9	7	10	13	16
Distance between columns	mm	1700	1700	2200	2200	2200	2200
Distance from spindle nose to table	mm	200~1200 (200~1400 / 200~1600)					
Spindle nose taper / tool shank		ISO NO.50 BT-50 . CAT-50 . DIN69871					
Spindle speed	rpm	60~4500 / 6000 (Option)					
Spindle motor (Cont. / 30min)	KW	22 / 18.5 (26 / 22)					
3 axes servo motors (x, y, z)	KW	7/7/7	7/7/7	7/7/7	7/7/7	6/7/7	9/7/7
Rapid traverse (x axis)	mm/min	12000	10000	12000	12000	10000	8000
Rapid traverse (y axis)	mm/min	12000	12000	12000	12000	12000	12000
Rapid traverse (z axis)	mm/min	10000	10000	10000	10000	10000	10000
Cutting feedrate	mm/min	6000					
Min. input unit	mm/min	0.001					
Tool magazine capacity	tools	32 / 40 / 60					
Max. tool dia. / adj pocket empty	mm	Ø125 / Ø250					
Max. tool length	mm	350					
Max. tool weight	kgs	12 / 25					
Power requirement	KVA	60	60	60	60	60	60
Pneumatic pressure requirement	kg/cm ²	6					
Machine net weight	t	36	42	40	47	55	62

Note: 1. Due to continuous research and development, the machine design and specifications are subject to change without prior notice.
2. Custom specifications are available upon request.

STANDARD ACCESSORIES

- Fanuc controller
- Semi full enclosure
- Auto lubrication system
- Screw type chip conveyor
- Coolant System
- Spindle oil cooler
- Nitrogen gas counter balance system
- Z-axis hydraulic counter balance system
- Spindle air blast
- Auto power off
- MPG
- Alarm Lamp
- RS-232 interface
- Leveling bolts & pads
- Tools & tool box
- Operation Manual

SP-2703	SP-2704	SP-2705	SP-2706	SP-3204	SP-3205	SP-3206	SP-3704	SP-3705	SP-3706
---------	---------	---------	---------	---------	---------	---------	---------	---------	---------

3000	4000	5000	6000	4000	5000	6000	4000	5000	6000
------	------	------	------	------	------	------	------	------	------

2600	2600	2600	2600	3100	3100	3100	3600	3600	3600
------	------	------	------	------	------	------	------	------	------

1000 (1200 / 1400)

2200x3000	2200x4000	2200x5000	2200x6000	2700x4000	2700x5000	2700x6000	3200x4000	3200x5000	3200x6000
-----------	-----------	-----------	-----------	-----------	-----------	-----------	-----------	-----------	-----------

11-22x200	11-22x200	11-22x200	11-22x200	13-28x200	13-28x200	13-28x200	15-28x200	15-28x200	15-28x200
-----------	-----------	-----------	-----------	-----------	-----------	-----------	-----------	-----------	-----------

2 / 6	2 / 8	2 / 10	2 / 12	3 / 8	3 / 10	3 / 12	3 / 8	3 / 10	3 / 12
-------	-------	--------	--------	-------	--------	--------	-------	--------	--------

10	13	16	19	16	20	24	18	23	28
----	----	----	----	----	----	----	----	----	----

2700	2700	2700	2700	3200	3200	3200	3700	3700	3700
------	------	------	------	------	------	------	------	------	------

200~1200 (200~1400 / 200~1600)

ISO NO.50 BT-50 . CAT-50 . DIN69871

60~4500 / 6000 (Option)

22 / 18.5 (26 / 22)

7/7/7	6/7/7	9/7/7	9/7/7	9/7/7	9/7/7	14/7/7	9/7/7	14/7/7	14/7/7
-------	-------	-------	-------	-------	-------	--------	-------	--------	--------

12000	10000	10000	8000	10000	10000	8000	10000	10000	8000
-------	-------	-------	------	-------	-------	------	-------	-------	------

12000	12000	12000	12000	12000	12000	12000	12000	12000	12000
-------	-------	-------	-------	-------	-------	-------	-------	-------	-------

10000	10000	10000	10000	10000	10000	10000	10000	10000	10000
-------	-------	-------	-------	-------	-------	-------	-------	-------	-------

6000

0.001

32 / 40 / 60

Ø125 / Ø250

350

12 / 25

60	60	60	60	60	60	65	60	65	65
----	----	----	----	----	----	----	----	----	----

6

44	51	58	65	56	63	70	61	69	77
----	----	----	----	----	----	----	----	----	----

OPTIONAL ACCESSORIES

- Upgrade to 6000rpm gear head
- Chain type magazine: 32T/40T/60T
- 4th axis rotary table
- Auto tool length measurement
- Auto work-piece measurement
- Linear scale feedback
- 90° / 45° angular milling head
- Universal milling head
- Coolant Through Spindle(70/bar)
- Oil water separating tank

KEEPING OUR CUSTOMERS IN THE LEAD

Top-One Machinery Co., Ltd. is an internationally recognized manufacturer of vertical machining centers and double column machining centers. Based on our outstanding R & D capabilities, company structure and experience, we are capable of both the design and manufacture of machining centers that feature greater machining capacity, higher accuracy and minimum trouble. Our objective is to offer the best possible machining centers to help customers stay competitive.



TOP-ONE MACHINERY CO., LTD.

No. 2-161, Shen Qing Road, Dong Shan Village

Qing Shui District, Taichung City 436, Taiwan

Tel: +886-4-2620-2901

Fax: +886-4-2620-2955

<http://www.topone-m.com>

E-mail: topone@topone-m.com